

Agilent 16095A Probe Fixture

Operating Note

Second Edition

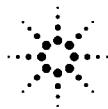

Agilent Technologies

Agilent Part No. 16095-90001

March 2000

Printed in Japan

Notices

The information contained in this document is subject to change without notice.

This document contains proprietary information that is protected by copyright. All rights are reserved. No part of this document may be photocopied, reproduced, or translated to another language without the prior written consent of the Agilent Technologies.

Agilent Technologies Japan, Ltd.

Component Test PGU-Kobe

1-3-2, Murotani, Nishi-Ku, Kobe-shi, Hyogo, 651-2241 Japan

Copyright © Agilent Technologies Japan, Ltd. 1990, 2000

Manual Printing History

The manual's printing date and part number indicate its current edition. The printing date changes when a new edition is printed. (Minor corrections and updates that are incorporated at reprint do not cause the date to change.) The manual part number changes when extensive technical changes are incorporated.

1990	First Edition (part number: 16095-90001)
March 2000	Second Edition (part number: 16095-90001)

Safety Summary

The following general safety precautions must be observed during all phases of operation, service, and repair of this instrument. Failure to comply with these precautions or with specific WARNINGS elsewhere in this manual may impair the protection provided by the equipment. In addition it violates safety standards of design, manufacture, and intended use of the instrument.

Agilent Technologies assumes no liability for the customer's failure to comply with these requirements.

- **Ground The Instrument**

To avoid electric shock hazard, the instrument chassis and cabinet must be connected to a safety earth ground by the supplied power cable with earth blade.
- **DO NOT Operate In An Explosive Atmosphere**

Do not operate the instrument in the presence of flammable gasses or fumes. Operation of any electrical instrument in such an environment constitutes a definite safety hazard.
- **DO NOT Substitute Parts Or Modify Instrument**









Because of the danger of introducing additional hazards, do not install substitute parts or perform unauthorized modifications to the instrument. Return the instrument to a Agilent Technologies Sales and Service Office for service and repair to ensure that safety features are maintained.

- **Dangerous Procedure Warnings**

Warnings, such as the example below, precede potentially dangerous procedures throughout this manual. Instructions contained in the warnings must be followed.

Safety Symbol

General definitions of safety symbols used on the instrument or in manuals are listed below.

-  Instruction Manual symbol: the product is marked with this symbol when it is necessary for the user to refer to the instrument manual.
-  Alternating current.
-  Direct current.
-  On (Supply).
-  Off (Supply).
-  In position of push-button switch.
-  Out position of push-button switch.
-  Frame (or chassis) terminal. A connection to the frame (chassis) of the equipment which normally include all exposed metal structure.

WARNING

This warning sign denotes a hazard. It calls attention to a procedure, practice, condition or the like, which, if not correctly performed or adhered to, could result in injury or death to personnel.

CAUTION

This Caution sign denotes a hazard. It calls attention to a procedure, practice, condition or the like, which, if not correctly performed or adhered to, could result in damage to or destruction of part or all of the product.

NOTE

Note denotes important information. It calls attention to a procedure, practice, condition or the like, which is essential to highlight.

Certification

Agilent Technologies certifies that this product met its published specifications at the time

of shipment from the factory. Agilent Technologies further certifies that its calibration measurements are traceable to the United States National Institute of Standards and Technology, to the extent allowed by the Institution's calibration facility, or to the calibration facilities of other International Standards Organization members.

Warranty

This Agilent Technologies instrument product is warranted against defects in material and workmanship for a period corresponding to the individual warranty periods of its component products. Instruments are warranted for a period of one year. Fixtures and adapters are warranted for a period of 90 days. During the warranty period, Agilent Technologies will, at its option, either repair or replace products that prove to be defective.

For warranty service or repair, this product must be returned to a service facility designated by Agilent Technologies. Buyer shall prepay shipping charges to Agilent Technologies and Agilent Technologies shall pay shipping charges to return the product to Buyer. However, Buyer shall pay all shipping charges, duties, and taxes for products returned to Agilent Technologies from another country.

Agilent Technologies warrants that its software and firmware designated by Agilent Technologies for use with an instrument will execute its programming instruction when properly installed on that instrument. Agilent Technologies does not warrant that the operation of the instrument, or software, or firmware will be uninterrupted or error free.

Limitation of Warranty

The foregoing warranty shall not apply to defects resulting from improper or inadequate maintenance by Buyer, Buyer-supplied software or interfacing, unauthorized modification or misuse, operation outside the environmental specifications for the product, or improper site preparation or maintenance.

IMPORTANT

No other warranty is expressed or implied. Agilent Technologies specifically disclaims the implied warranties of merchantability and fitness for a particular purpose.

Exclusive Remedies

The remedies provided herein are buyer's sole and exclusive remedies. Agilent Technologies shall not be liable for any direct, indirect, special, incidental, or consequential damages, whether based on contract, tort, or any other legal theory.

Assistance

Product maintenance agreements and other customer assistance agreements are available for Agilent Technologies products.

For any assistance, contact your nearest Agilent Technologies Sales and Service Office. Addresses are provided at the back of this manual.

1. INTRODUCTION

This operating note provides all the information required to operate and maintain the HP Model 16095A Probe Fixture. To order additional copies of this operating note, use the part number given on the rear cover and contact the nearest Hewlett-Packard Sales and Service Office.

2. DESCRIPTION

The Model 16095A Probe Fixture, pictorially shown on the front cover, is designed for use with the Model 4192A LF Impedance Analyzer. It is intended for grounded or floating measurements on board-mounted components or entire circuits. An OSC OUTPUT (test signal from the 4192A) terminal is provided to facilitate relative gain-phase and group-delay measurements, without disconnecting the test fixture. Specifications are listed in Table 1; furnished accessories, along with their part numbers, are shown in Figure 1.

Table 1. Specifications

Function:	Probed impedance measurements on board-mounted components or entire circuits. Used with the Model 4192A LF Impedance Analyzer.
Coupling:	PROBE Capacitive coupling (2.2 μ F) OSC OUT Direct coupling
Parasitic Elements (specified when BNC adapter is connected to probe tip):	
Stray capacitance:	$\leq 15\text{pF}$
Residual inductance:	$\leq 40\text{nH}$
Residual resistance:	$\leq 100\text{m}\Omega$

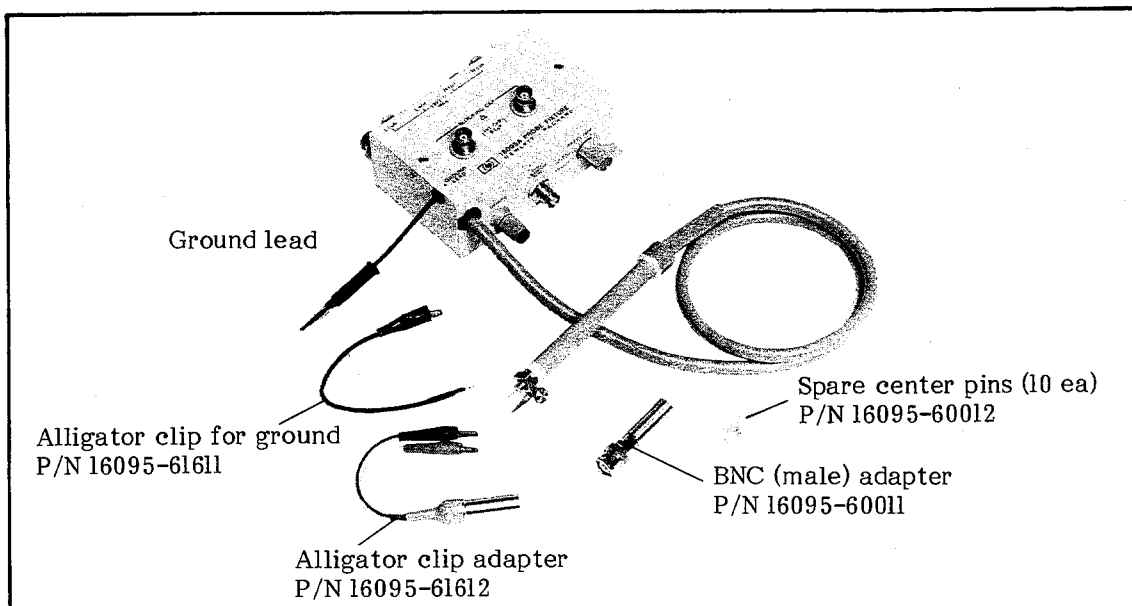

Figure 1. Model 16095A and accessories.

3. OPERATION

3-1. Connection to 4192A

Set the CABLE LENGTH switch (located on the front-panel of the 4192A) to the 1m position then connect the 16095A directly to the UNKNOWN terminals of the 4192A.

3-2. Zero Offset Adjustment

Additive errors, caused by the parasitic elements (residual inductance and resistance, stray capacitance) of the test fixture and test leads, affect measurement accuracy. Thus, before making an impedance measurement, OPEN and SHORT zero offset adjustments must be performed at each measurement condition. The procedure is as follows :

1. Set the 16095A's selector switch to the PROBE position.
2. Set the 4192A's controls as required for the desired measurement.
3. Connect the standard probe tip, BNC adapter, or alligator clip adapter to the probe.
4. Perform OPEN zero offset adjustment as described in the 4192A's operation and service manual.
5. Short the HIGH and LOW leads of the probe tip.
6. Perform SHORT zero offset adjustment as described in the 4192A's operation and service manual.

Note

Zero offset adjustment data is valid for only one frequency range. For details, refer to Table 3-18 in the 4192A's operation and service manual.

3-3. DUT Connection

DUTs can be connected in one of three ways : (1) using the standard probe tip, (2) using the alligator clip adapter, or (3) using the BNC adapter. The standard probe tip is best for probing in-circuit, board-mounted components. The alligator clip adapter is for components too large for the standard probe tip, and for circuits or networks not equipped with BNC connectors. It is also easier to use than the standard probe tip because it does not have to be held during measurement. The BNC adapter is used to connect circuits or networks equipped with BNC connectors.

CAUTION

WHEN MEASURING CHARGED CAPACITORS, BATTERIES, OR ACTIVE CIRCUITS, DO NOT ALLOW A VOLTAGE EXCEEDING $\pm 35V$ ACROSS THE HIGH AND LOW TERMINALS OF THE PROBE. ALSO, WHEN USING THE EXTERNAL BLOCKING CAPACITOR DESCRIBED IN 3-4, MAXIMUM VOLTAGE IS $\pm 10V$. VOLTAGES HIGHER THAN THESE MAY BLOW THE FUSE IN THE 4192A'S MEASUREMENT CIRCUIT.

CAUTION

DO NOT SET THE SELECTOR SWITCH TO THE OSC OUTPUT POSITION WHILE A DC VOLTAGE IS APPLIED. TO DO SO MAY DAMAGE THE SELECTOR SWITCH CONTACTS.

Note

Standard probe tip and BNC adapter can be used at frequencies up to 13MHz. However, the alligator clip adapter should not be used at frequencies above 100kHz.

3-4. Blocking Capacitor

The 16095A is equipped with a $2.2\mu\text{F}$ internal blocking capacitor in order to block the DC voltage of the DUT. This blocking capacitor, however, increases the output impedance of the test signal source, and, consequently, reduces the level of the test signal. Because of this, accurate impedance measurements on active devices are possible only above a specified frequency for a given $|Z|$ range. Refer to the graph below.

For example, if the impedance of the DUT is $9\text{k}\Omega$, the 4192A automatically selects the $10\text{k}\Omega$ range. On this range the lowest useable test signal frequency is approximately 80Hz . At frequencies below this, measurement accuracy decreases. For measurements at lower frequencies, the value of the blocking capacitor must be increased. To do this, a capacitor must be connected to the BLOCKING CAP terminals as shown in the figure below. The value of this capacitor must be equal to the required capacitance (determined from the graph) minus $2.2\mu\text{F}$, the value of the internal blocking capacitor.

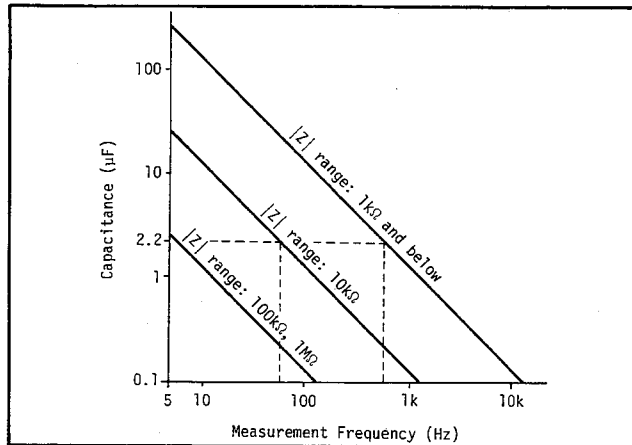

Figure 2. Frequency limitation for the blocking capacitor and ZY range.

The external blocking capacitor should be nonpolarized, and must have a working voltage of $\geq 50\text{V}$. It should be connected using BNC connectors. Also, to reduce noise pick-up and to prevent a potential shock hazard, the capacitor and its leads should be inclosed in a grounded shielding case.

For measurements on passive components and circuits, the internal blocking capacitor can be, effectively, removed from the circuit by connecting a BNC-to-BNC cable between the BLOCKING CAP terminals. There are, then, no frequency limitations.

CAUTION

WHEN THE BLOCKING CAP TERMINALS ARE SHORTED, DO NOT CONNECT THE PROBE TO AN ACTIVE CIRCUIT, CHARGED CAPACITOR, OR BATTERY. TO DO SO MAY BLOW THE FUSE IN THE 4192A'S MEASUREMENT CIRCUIT.

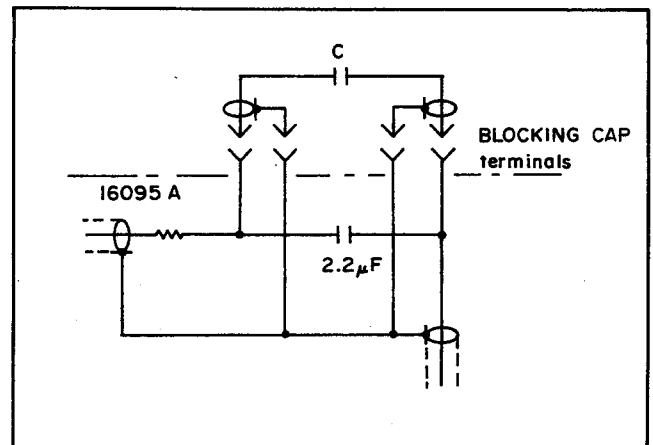

Figure 3. External capacitor connection.

3-5. FLOATING AND GROUNDED MEASUREMENTS

The 4192A can measure either floating or grounded components because all the measuring circuits in the 4192A are floating above power line ground. There are, however, some important points to keep in mind when making these measurements.

Floating Measurements

- (1) Do not connect the ground lead of the 16095A to the 4192A's GND (\perp) terminal.
- (2) When measuring in-circuit components, the guard point must be carefully selected. Refer to 3-6.
- (3) The lead used to connect the 16095A's GUARD terminal to the guard point should have a low residual impedance.

Grounded Measurements

- (1) The ground lead of the 16095A must be connected to the 4192A's GND (\perp) terminal.
- (2) Connect nothing to the 16095A's GUARD terminal.
- (3) Connect the LOW terminal of the 16095A's probe to the low (grounded) terminal of the DUT.

CAUTION

WHEN LOW GROUND MEASUREMENT IS MADE, DO NOT CONNECT THE LOW TERMINAL OF THE 16095A TO ANY POINT THAT IS NOT AT GROUND POTENTIAL. TO DO SO MAY DAMAGE THE 4192A AND 16095A OR CIRCUIT UNDER TEST.

3-6. GUARDING

When making a floating measurement on an in-circuit component, guarding must be used to negate the effects caused by other components in the circuit. Referring to the simple circuit shown below, to measure the impedance of Z_x , the HIGH and LOW terminals of the 16095A probe are connected across Z_x and the 16095A's guard terminal is connected to a common point between Z_a and Z_b .

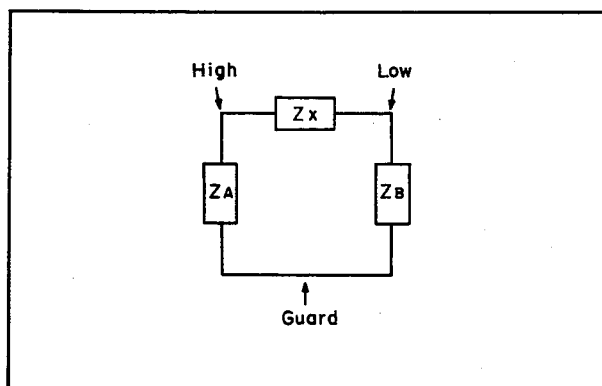

Figure 4. Guarding to the common point.

Since the guard point is at the same potential as the ground reference of the signal source, and since the potential difference between the low terminal of the probe and the guard point is maintained at approximately 0V by the measurement circuit of the 4192A, the current through Z_b is almost zero. Z_a is in series with the output impedance of the signal source, forming a voltage divider which reduced the amplitude of the test signal across Z_x . But since the 4192A measures only current through, and voltage across, Z_x , Z_a has negligible effect on the measured value of Z_x .

Sources of measurement error are Z_a , Z_b , and the impedance of the guard lead. Each is outlined below :

(1) Z_a

Because Z_a is shunted across the signal source, the amplitude of the test signal across Z_x is lowered in proportion to the impedance of Z_a .

(2) Z_b

Because Z_b is in parallel with the input impedance of the I-V Converter, the effective sensitivity of the bridge circuit is lowered.

(3) Guard lead impedance

The lead used to connect the guard terminal of the 16095A to the circuit guard point has an impedance, represented as Z_r in the figure below. By converting the T-network of Z_a , Z_b , and Z_r to a delta-network, it can be shown that an impedance, Z_{ab} , is in parallel with Z_x .

The value of Z_{ab} is calculated as :

$$Z_{ab} = \frac{Z_a Z_b + Z_r (Z_a + Z_b)}{Z_r}$$

$$\approx \frac{Z_a Z_b}{Z_r} \quad (\text{if } Z_r \ll Z_a // Z_b)$$

The measured impedance, then, is equal to :

$$Z_{meas} = \frac{Z_x Z_{ab}}{Z_x + Z_{ab}}$$

To minimize these errors, the guard point must be carefully selected and the guard lead must have low impedance ($\leq 20m\Omega$).

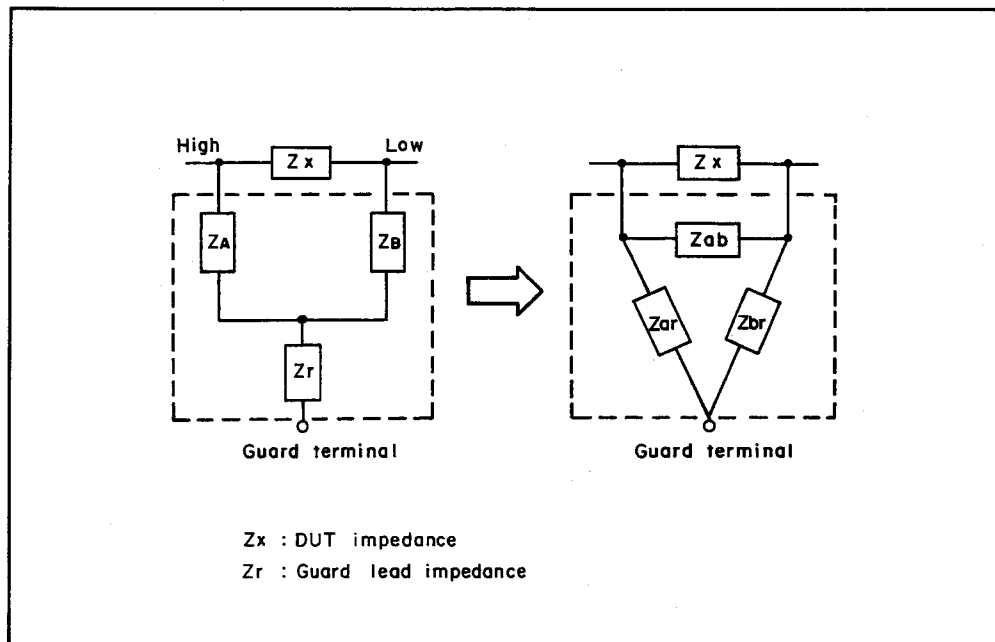

Figure 5. Conversion of guard circuit.

4. MAINTENANCE

The schematic diagram of the 16095A, along with part numbers of the electrical components, is shown in Figure 6. An exploded view of the 16095A is shown in Figure 7. Do not disassemble any further than shown. Figure 7 also includes a replaceable parts list. Use the Hewlett-Packard part number when ordering a part. If a defective part is located in an assembly that cannot be disassembled, order the next higher assembly or return the 16095A to the nearest Hewlett-Packard Sales/Service Office for repair or replacement. A listing of Sales/Service Offices is given on the rear cover.

Note

For optimum contact, keep the contact surface of the center pin (at the probe tip) clean. Use a lint-free, dry cloth, and, if a cleaning fluid is required, use isopropyl alcohol.

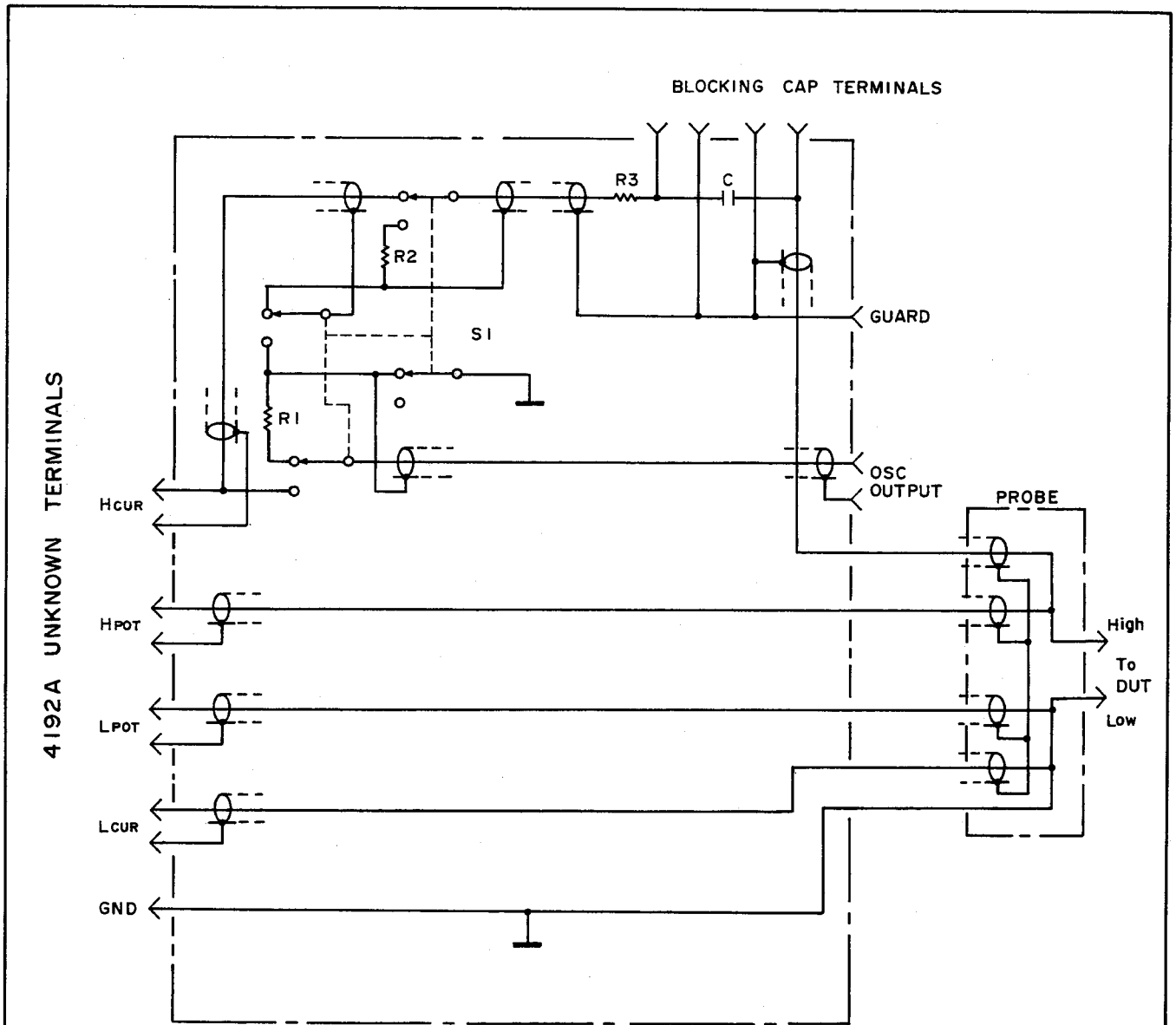

Note : S1, SELECTOR SWITCH, is set to PROBE.

Reference	HP Part Number	Qty	Description
C	0160-0128	1	CAPACITOR-FXD 2.2 μ F20% 50VDC
R1	0757-0394	1	RESISTOR 51.1 Ω 1% 0.125W
R2	0757-0398	1	RESISTOR 75 Ω 1% 0.125W
R3	0757-0984	1	RESISTOR 10 Ω 1% 0.5W
S1	3100-1459	1	SWITCH, ROTARY

Figure 6. Model 16095A Schematic Diagram.

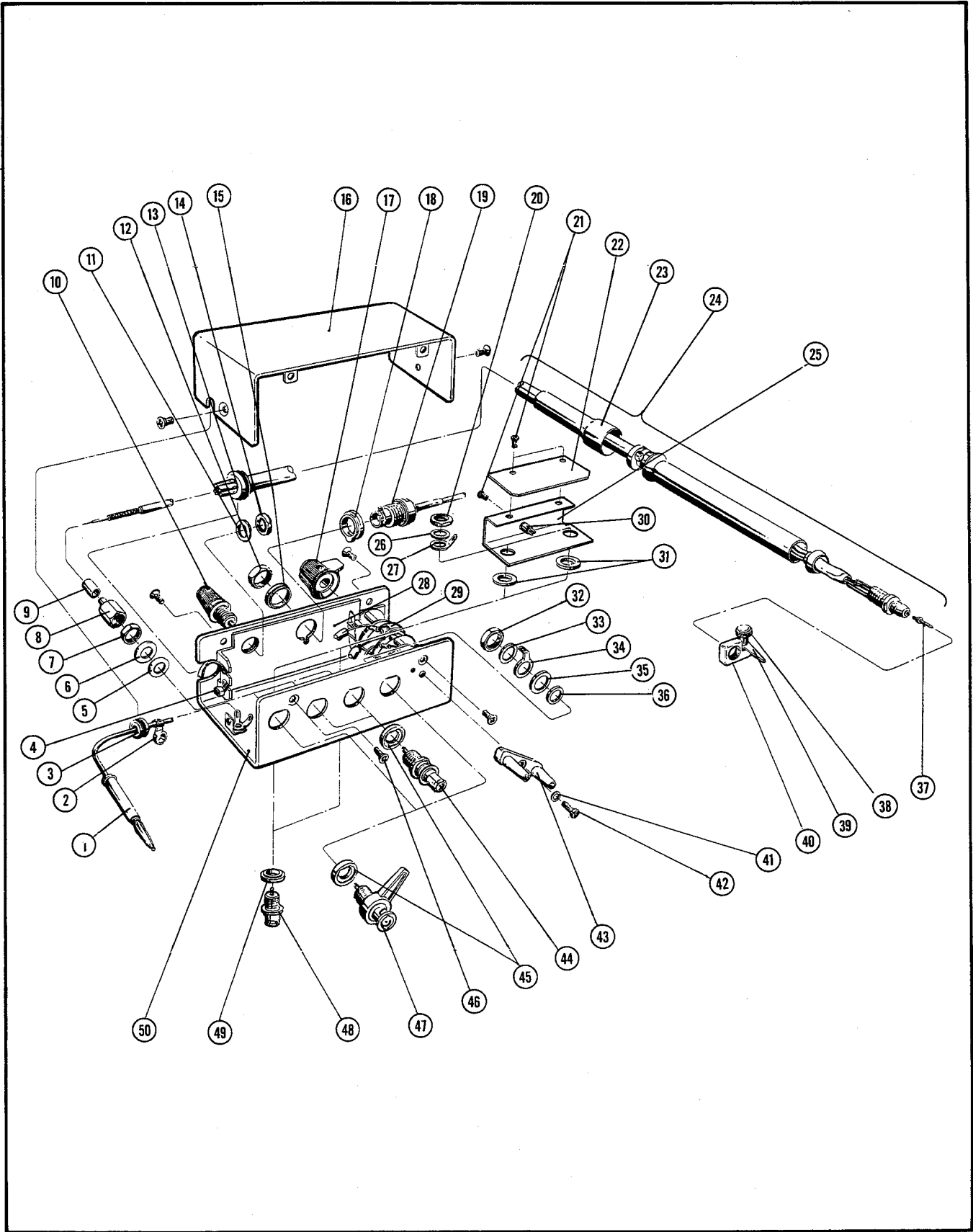

Figure 7. Parts Identification for 16095A (Sheet 1 of 2)

Reference	HP Part Number	Qty	Description
1	16095-61603	1	LEAD-GROUND
2	1400-0719	1	CABLE TIE
3	0400-0203	1	GROMMET
4	1400-0249	2	CABLE TIE
5	*	4	INSULATOR
6	*	5	WASHER
7	*	6	NUT
8	*	3	NUT
9	*	3	SLEEVE
10	1510-0107	1	POST
11	2190-0016	4	WASHER
12	2950-0035	1	NUT
13	*	1	GROMMET
14	2950-0043		NUT
15	04271-50024	1	INSULATOR
16	16095-04002	1	COVER-BOTTOM
17	0370-2994	1	KNOB
18	04271-50025	1	INSULATOR
19	1250-0252	1	CONNECTOR-BNC
20	2950-0043		NUT
21	2200-0103	3	SCREW
22	16095-00603	1	SHIELD
23	*	1	SLEEVE
24	*		PROBE and CABLE ASSEMBLY
25	16095-00602	1	SHIELD
26	2190-0016		WASHER
27	0360-1190	2	TERMINAL
28	16095-00601	1	PANEL-SUB
29	3100-1659	1	SWITCH-ROTARY
30	0360-1497	1	TERMINAL
31	5040-0345	2	INSULATOR
32	2950-0043		NUT
33	2190-0016		WASHER
34	0360-1190		TERMINAL
35	3050-0067		WASHER
36	3050-0789		INSULATOR
37	16095-29005	1	PIN-CENTER
38	16095-24001	1	SCREW
39	16094-09001	1	PIN-GROUND
40	16095-24002	1	NUT
41	2190-0206	1	WASHER
42	2200-0105	1	SCREW
43	16047-40000	1	STOPPER
44	*	2	CONNECTOR-BNC
45	16047-40002	4	INSULATOR
46	2360-0192	6	SCREW
47	16012-7122	2	CONNECTOR-BNC
48	1250-0118	2	CONNECTOR-BNC
49	5040-0345		INSULATOR
50	16095-04001	1	COVER-TOP
	16095-60001 ¹	1	PROBE FIXTURE (① thru ⑤)

¹ Agilent internal-only part number.

*: NOT SEPARATELY REPLACEABLE.

Figure 7. Parts Identification for 16095 A (Sheet 2 of 2.)

REGIONAL SALES AND SUPPORT OFFICES

For more information about Agilent Technologies test and measurement products, applications, services, and for a current sales office listing, visit our web site: <http://www.agilent.com/find/tmdir>. You can also contact one of the following centers and ask for a test and measurement sales representative. 11/29/99

United States:

Agilent Technologies
Test and Measurement Call Center
P.O.Box 4026
Englewood, CO 80155-4026
(tel) 1 800 452 4844

(fax) (61 3) 9272 0749
(tel) 0 800 738 378 (New Zealand)
(fax) (64 4) 802 6881

Canada:

Agilent Technologies Canada Inc.
5150 Spectrum Way
Mississauga, Ontario
L4W 5G1
(tel) 1 877 894 4414

Asia Pacific:

Agilent Technologies
24/F, Cityplaza One, 1111 King's Road,
Taikoo Shing, Hong Kong
(tel) (852)-3197-7777
(fax) (852)-2506-9284

Europe:

Agilent Technologies
Test & Measurement
European Marketing Organization
P.O.Box 999
1180 AZ Amstelveen
The Netherlands
(tel) (31 20) 547 9999

Japan:

Agilent Technologies Japan Ltd.
Call Center
9-1, Takakura-Cho, Hachioji-Shi,
Tokyo 192-8510, Japan
(tel) (81) 426 56 7832
(fax) (81) 426 56 7840

Latin America:

Agilent Technologies
Latin American Region Headquarters
5200 Blue Lagoon Drive, Suite #950
Miami, Florida 33126
U.S.A.
(tel) (305) 267 4245
(fax) (305) 267 4286

Australia/New Zealand:

Agilent Technologies Australia Pty Ltd
347 Burwood Highway
Forest Hill, Victoria 3131
(tel) 1-800 629 485 (Australia)